

Opening the THz-Spectrum for Communication in 5G and Beyond

- [Florian Pivit](#)
- 'Towards Tera-Hertz Communications', 05.02.2020, Lausanne

The Triangle of Truth

More bandwidth!

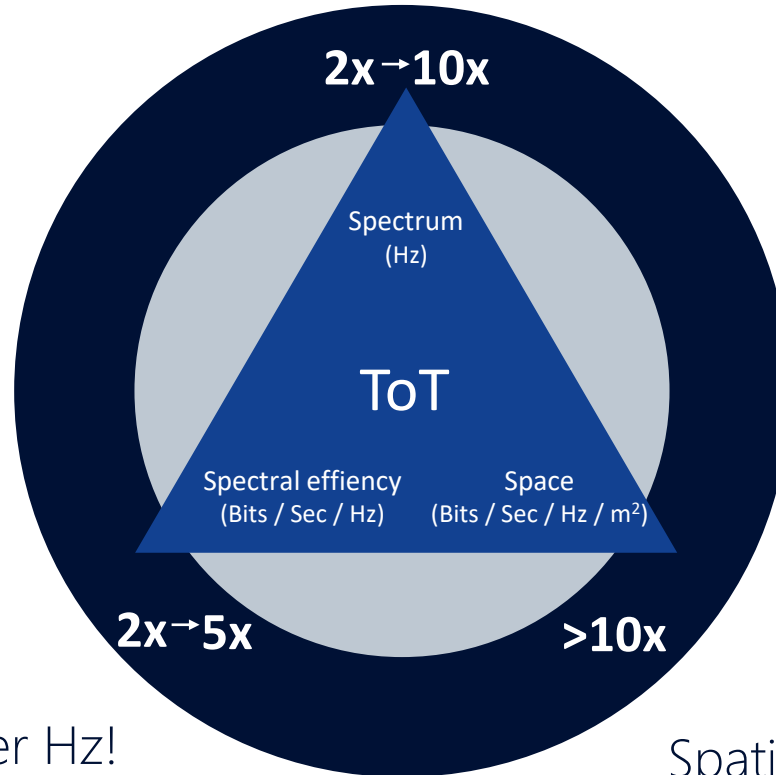

More bits per Hz!

Small cells,
Spatial re-use, MIMO!

A New Networking & Connectivity Era

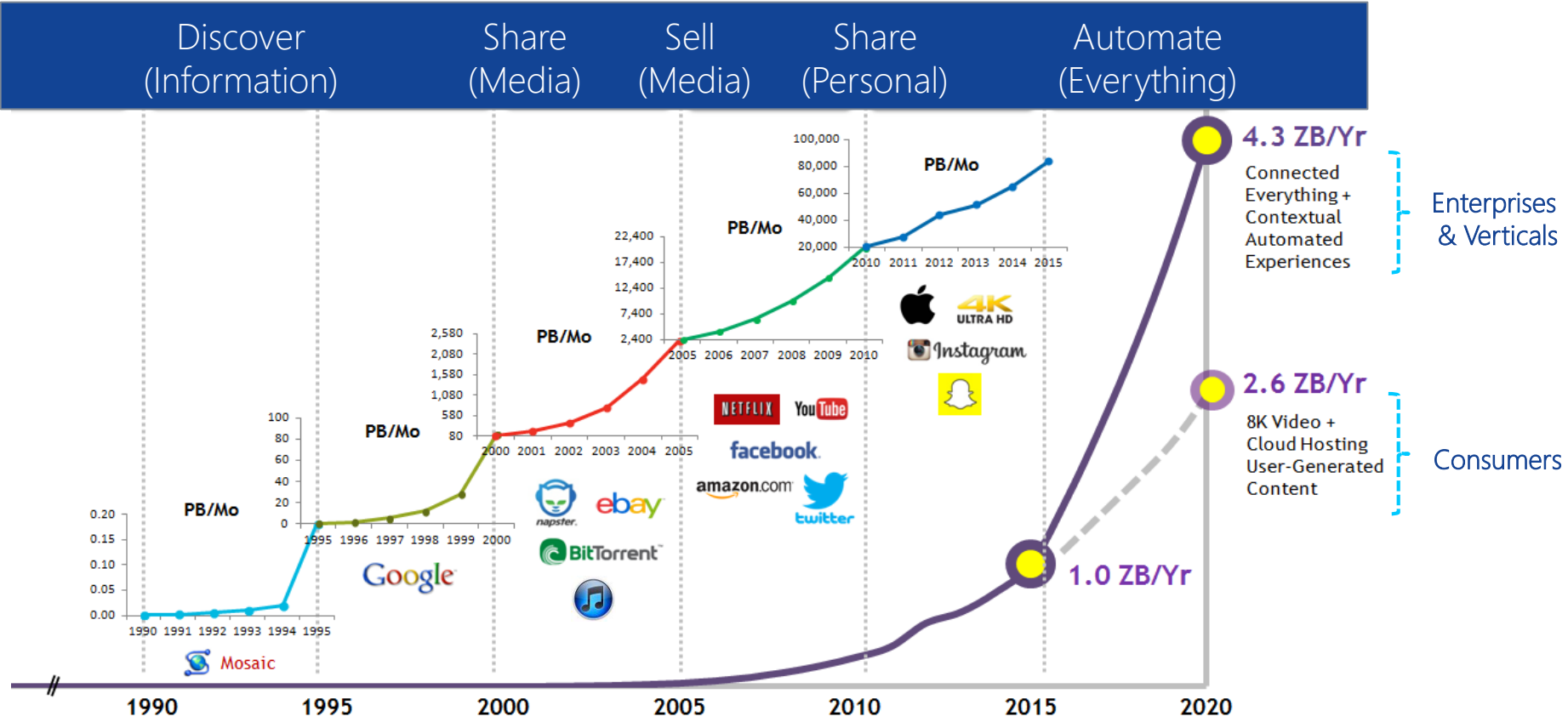

VR and AR generate huge amounts of data traffic

- Immersive 'field of view' for Virtual Reality → 'virtual screen' is much larger (e.g. 20x)
 - 150° x 120° vs. 30° for HDTV
 - With head + body motion, FoV can be 360° x 180°

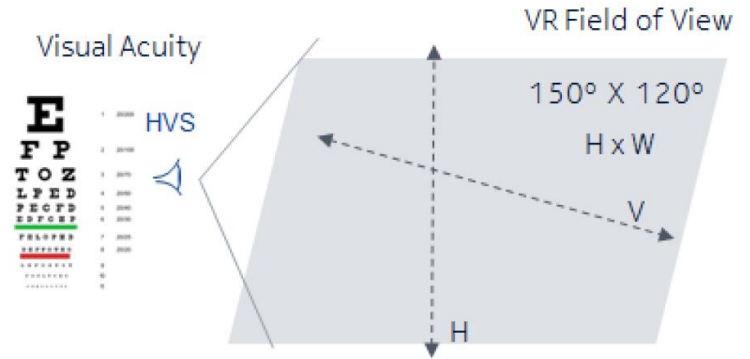
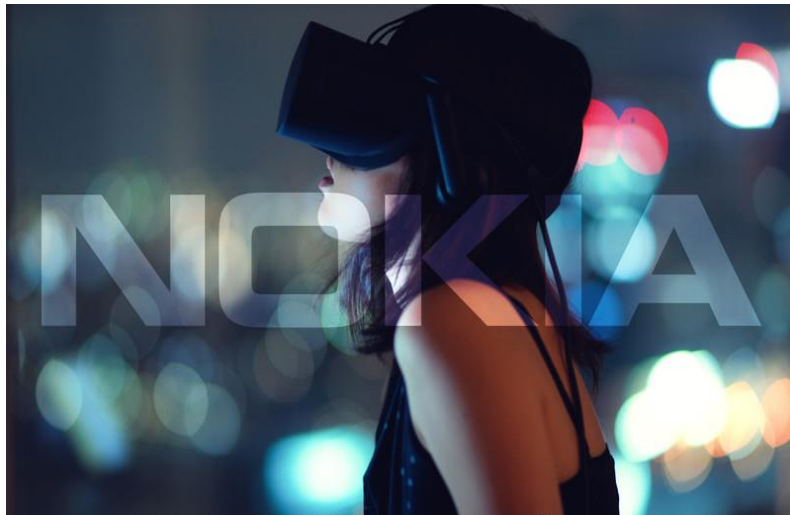

Example:

- Visual Acuity (1 arc min); Frame Rate 60/sec; H265 Encoding (.08 - .125 bits/pixel)
- **VR Bandwidth ~0.4 – 0.7 Gbps**

Q: How to create more capacity on our overcrowded spectrum?

A: 5G and mm-wave!



The Six Essential 5G Technologies

New Virtualized + Software-Defined Core for flexible routing through centralized, distributed, gateways optimized for any service mix

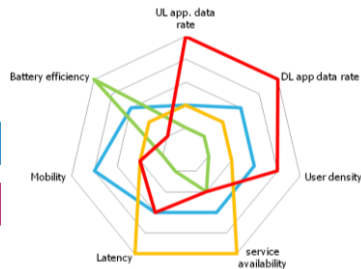
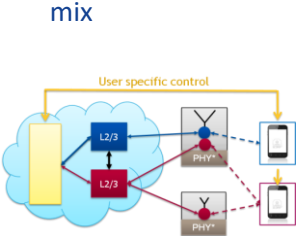

Multi-RAT with network controlled traffic steering and cell-less architecture

- ~2X increase data rate
- Guaranteed user/service experience

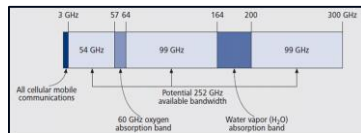
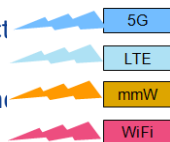

< Public >

Modular Framing Structure for ultra-broadband, ultra-narrowband and ultra-low latency support

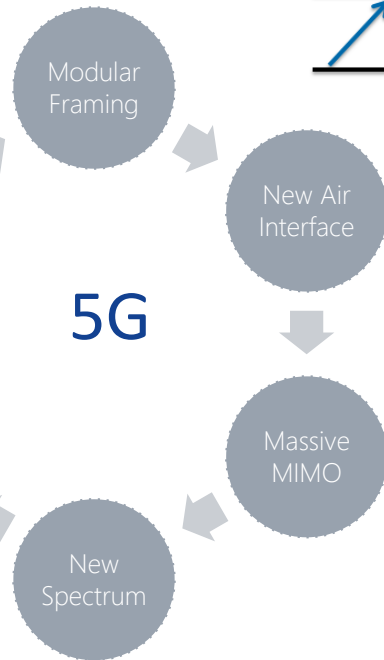
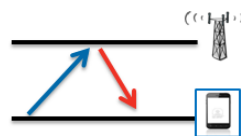
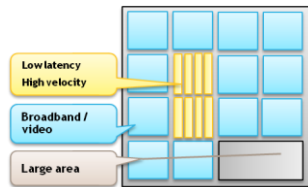

New "mmWave" spectrum small cells

- ~10X bandwidth

New Air Interface: New Waveform and control for flexible multi-service interface

- ~2X battery life
- ~5X lower latency

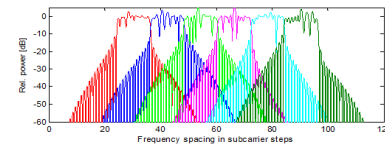
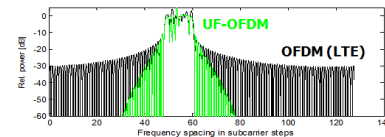

Massive MIMO

Higher spectral efficiency through spatial multiplexing (beamforming)

- ~5X increase in spectral efficiency

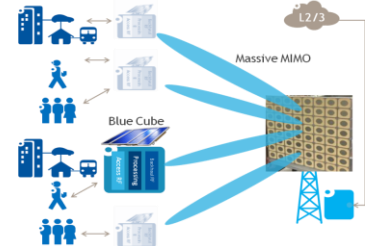

5G New Frequency Bands above 52.6 GHz

- unlicensed spectrum on 60GHz
- licensed/lightly-licensed spectrum on 66~76GHz and 81~86GHz targeting industrial, private network for in-building, local area environments



An abundance of bandwidth becomes available for wireless communication ...

FCC voted unanimously in [July 2016](#) on the historic Spectrum Frontiers plan to free up *vast amounts of spectrum* for 5G. The move *effectively quadrupled the amount of radio bandwidth ever made available to the mobile industry*.

"A historic moment, a turning point, as the Renaissance of wireless begins."
(T. Rappaport, NYU Wireless)

"There is no doubt that giant new businesses and applications that exploit this unprecedented spectrum will change our world in amazing ways over the next decade."

"The next wireless evolution promises to fundamentally change the way we live, interact and engage with our communities. ... There is seemingly no limit on how what we refer to as 5G could impact our everyday existence."
(Mignon Clyburn, FCC Commissioner)

Facebook already built a sizable **60 GHz network in San Jose**, California; the 60 GHz ecosystem is growing.

"the commission is seeking to unleash new *spectrum in frequencies above 95 GHz – Way, way up there is spectrum that some see as going overboard*"
"There's something 'undeniably cool' about putting these stratospheric frequencies to use and converting their propagation challenges into opportunity" - [Commissioner Jessica Rosenworcel](#), ([fiercewireless.com](#))

Will this be enough to solve the wireless spectrum problem?

Going beyond 5G – THz and optical

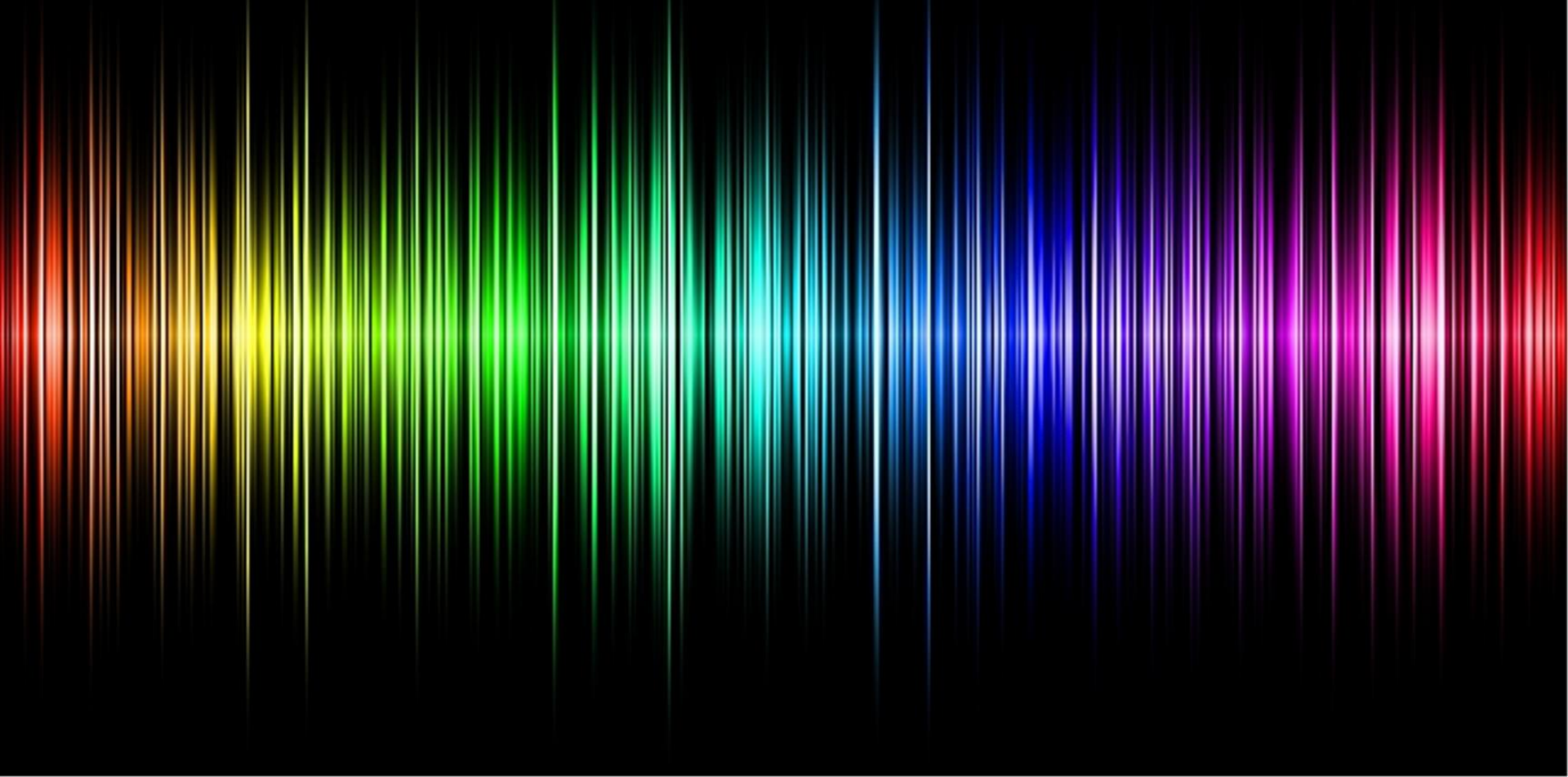

Propagation of THz Signals

Challenges

- Line of Sight propagation path / free space loss
 - Need for high gain antennas
 - Thermal challenges (heat dissipation in highly integrated antennas)
- Molecular absorption loss dominated by water vapor
 - Frequency dependency (features “Windows”)
 - Exponential characteristic (Lambert-Beer law) $\frac{I}{I_0} \sim e^{-c\varepsilon R}$
 - Molecular absorption noise
- Rain attenuation up to 30dB/km (Nagatsuma)
- Small wavelengths lead to significant scattering effects
- Coverage Requires High Antenna Count -> **Challenging MAC**
- **Mobility** is Challenging (Beam Tracking, 100s of Antennas)
- Network Planning (**3D models of environment**)

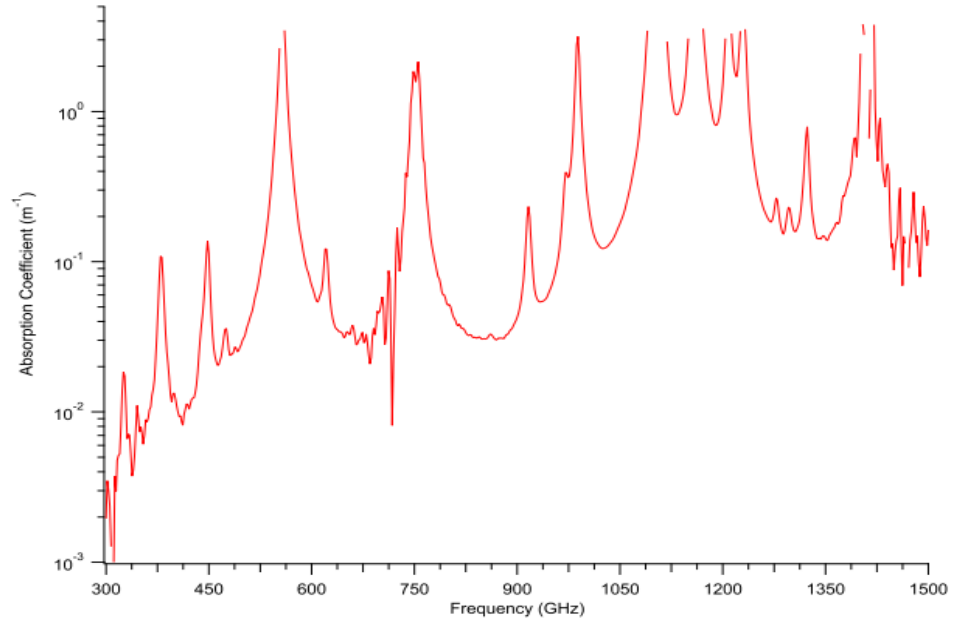

D.M. Slocum et al., Atmospheric absorption of terahertz radiation and water vapor continuum effects, *J. of Quantitative Spectroscopy and Radiative Transfer*, 127, 2013, pp 49-63

The THz Gap

Challenging Generation and Detection of THz Radiation

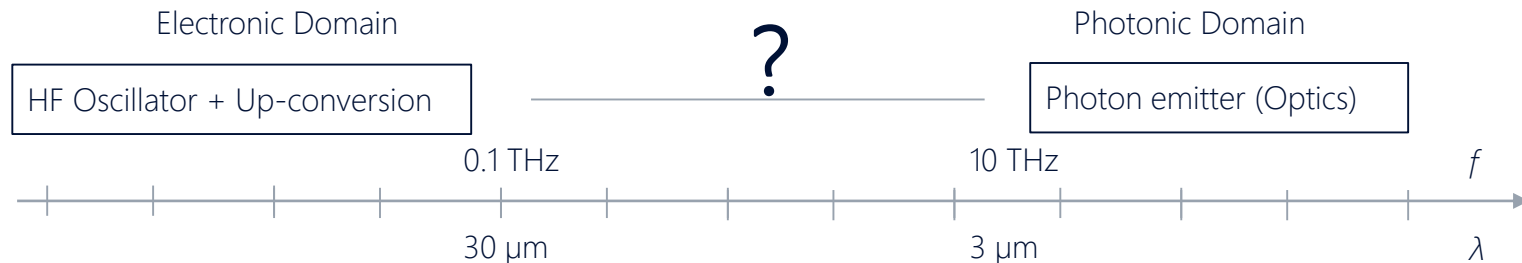

Electronic

- Inefficient up-conversion of oscillator signals
- Small antenna aperture
- Signal sources
 - Hi bandwidth transistor
 - SiGe HBT ($f_t/f_{max} < 500\text{GHz}$) $\sim 300\text{GHz}$
 - GaN, InP metamorphic materials ($f_{max} < 1200\text{GHz}$)
 - Resonant Tunnelling Diodes (RTDs) (1.92THz, 0.4μW)
 - Coherent Arrays?
 - Low Output Power

Optical/Photonic

- At room temperature and $f \sim 6\text{THz}$: $kT \sim \hbar\omega \rightarrow$ photon energy in range of thermal excitation
- Quantum Cascade Laser (3.2THz, $T=200\text{K}$)
- Optical signal generation w. down-conversion
- Optical mixing/heterodyning

Plasmonics

- E.g. Graphene research
 - Nano-antenna: Surface Plasmon Polariton (SPP) waves in semi-finite size Graphene Nanoribbons (GNRs)
 - Smith-Purcell Based THz-emitter

○ $\sim 0.1\text{--}30\text{THz}$, $P/A \sim 0.5\text{W/cm}^2$



So ... after all this it seems THz-communication faces similar challenges like free space optical communication.

..... but it offers smaller bandwidth

Why do we go for it?

Potential THz Applications

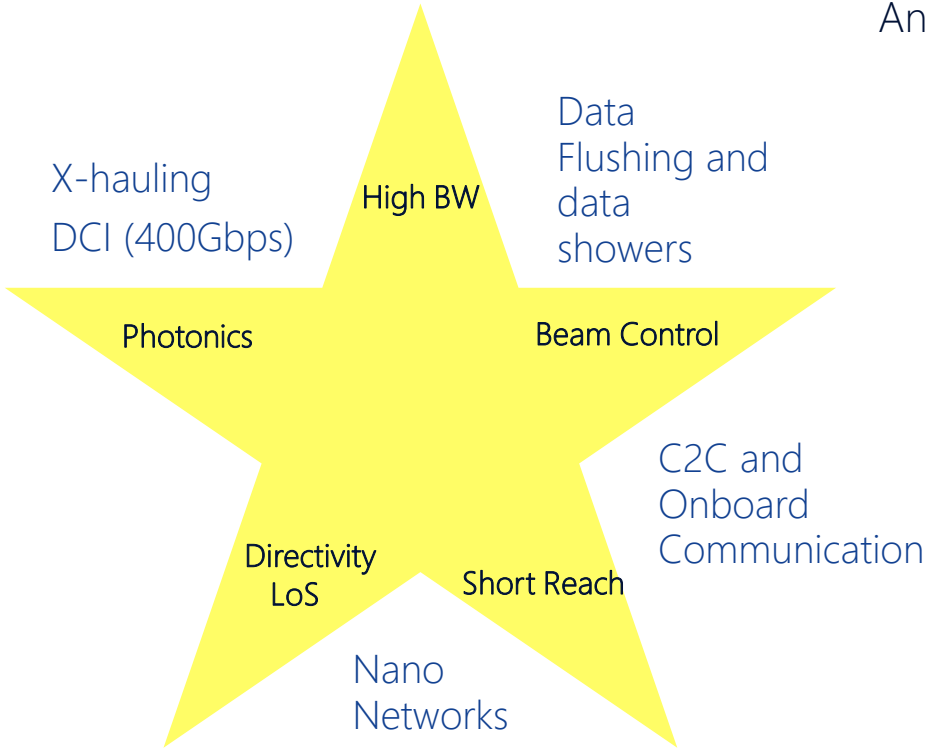

Antenna size and high gain arrays can be the answer!

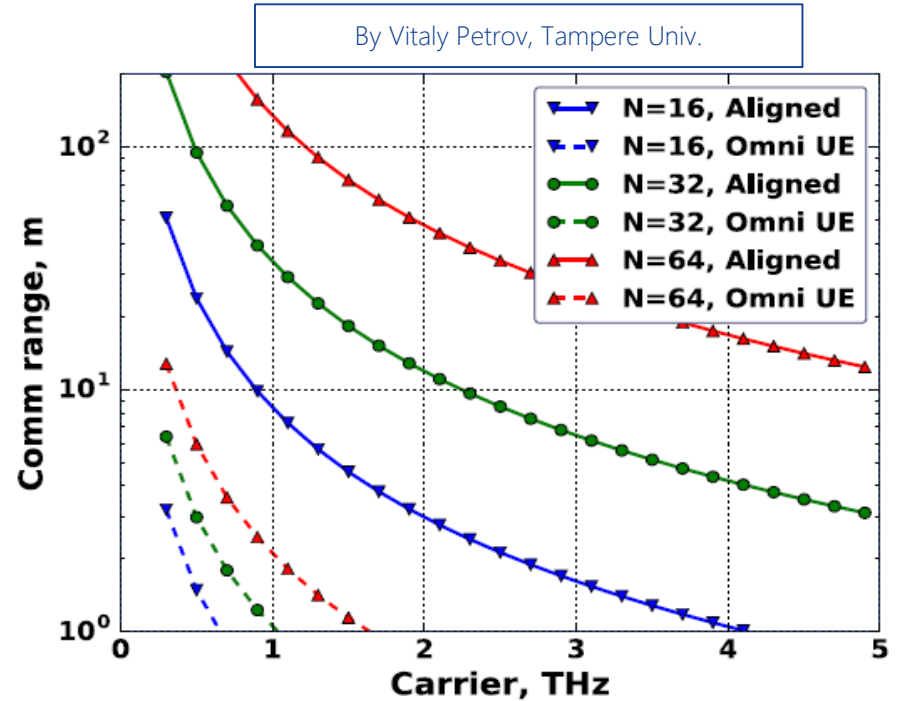

A circular tunnel constructed from a complex, woven mesh of light-colored material. The mesh consists of interlocking, diamond-shaped or lattice-like patterns that create a sense of depth and texture. The tunnel leads to a bright, circular opening that reveals a sky filled with soft, white clouds and patches of blue. The overall composition is symmetrical and centered, with the text overlaid on the sky view.

Where are
we
on our
journey?

H2020-Project iBROW

Exploring Resonant Tunnel-Diode (RTD) based THz communication



Partners:
Univ. Glasgow, IQE, Univ. Lisbon,
Vivid Components, INESC TEC, CST
Global, Optocap, III-V Lab, CEA-
LETI,
TU Braunschweig, Nokia Bell-Labs

Project Content:

- High performing RTDs, a.o.:
 - 2mW @ 84GHz, 1mW @ 307 GHz
- Integrated antenna designs
 - $F_c=280\text{GHz}$, BW 40GHz, 5dbi
- Models for THz propagation in Indoor environment
- RTD Photodetector (see right side graph)**
 - DC Response 5A/W @ 1310nm
 - III/V direct growth on Si
- Transmission experiments:
 - 15Gbit/s @ 84GHz
- Amendment f. IEEE 802.15.3-2016
- Concept for integrated mmW/photonic backhauling

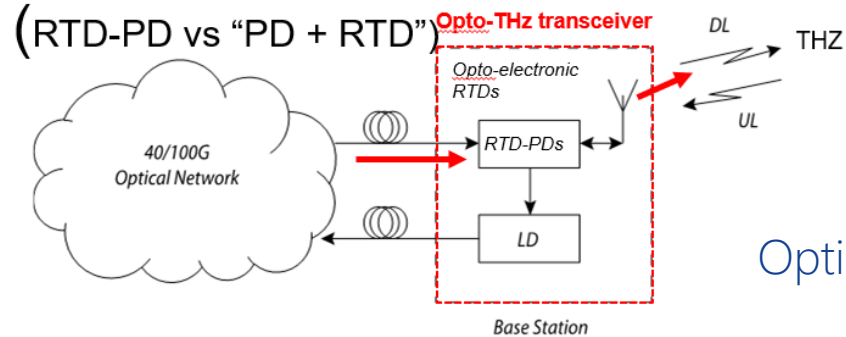

Optical THz excitation

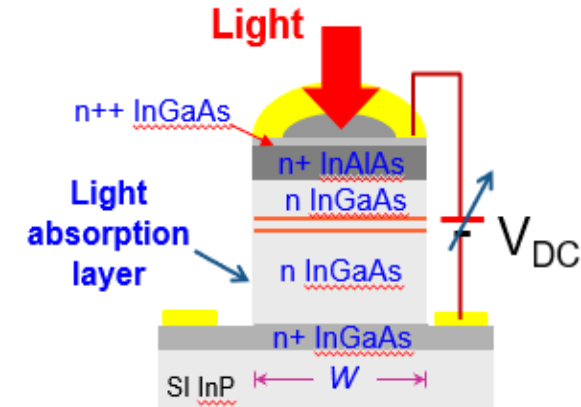

Looking ahead - iBROW+

The next steps:

- Open Questions to address
 - Are RTDs a suitable solution?
 - Evolution of TRX technologies to higher frequency, bandwidth and output power
 - After first experiences below 100GHz, targeting $F_c > 300\text{GHz}$, 100Gbit/s , $P_{\text{out}} > 2.5\text{mW}$
 - Feasibility of low cost mass production
 - (m)MIMO technologies and coherent RTD Arrays ($4 \times 2.5\text{ mW}$)
 - Phased array solutions with beam steering to support moving terminals
 - Modulation formats and signal processing supporting THz communication
 - Benchmarking vs. conventional approaches for electronic THz-signal generation (InP HBT)

Mm-wave and THz novel transceiver technology

Coherent RTD arrays

- Main drawback of RTD-based sources is the limited output power (P_{OUT}): $P_{OUT} < 2\text{mW}$
- Alternative to increase the power and cope with limited aperture: coherent RTD array
e.g. 4-elem RTD array: $P_{OUT} > 10\text{mW}$
- Coherent operation can be achieved through injection-locking by means of an external reference/synchronization signal

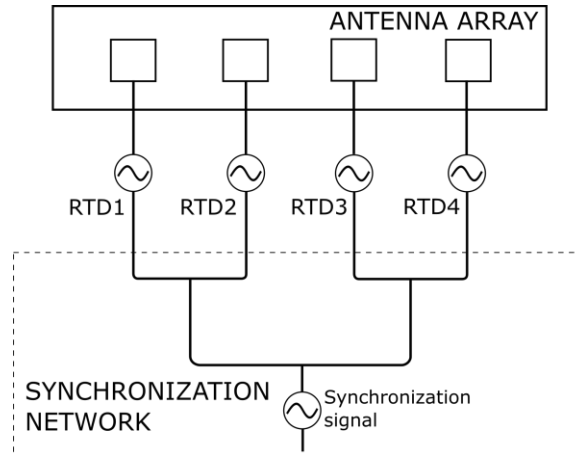

Plasmonic Transceivers

Plasmonics: Interaction between free electrons in (metal) nano-layers and light.

- Plasmonic e/o and o/e conversion
- Direct conversion from wireless to optical
- Avoid any radio frontend electronics
- Wave Lengths: 1460 – 1625nm / 1260 – 1360nm)
- Targeting Bitrates of 100 Gbit/s, -> BW of several 10 GHz
- Metamaterials featuring tunability based on plasmonics

Reported Achievements (Leuthold et. al., IEF, ETH Zurich):

- Direct e/o conversion using plasmonic mixer integrated with resonant four-leaf-clover antenna
- Transmitted 20 Gbit/s (1m) and 10 Gbit/s (2m) @ $f_c = 60$ GHz
- Compatible with Si-technology integration

Surface Plasmons generated by incident light modulate mmWave traveling along slot via Pockels effect in the Dielectric medium in the slot

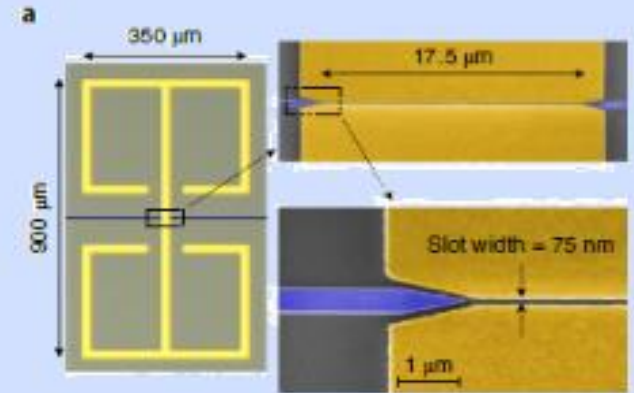

Microwave plasmonic mixer in a transparent fibre-wireless link
Salamin et al., nature photonics, Oct. 2018

Indoor Communication

A Future Vision & Summary

- Highly Integrated components (active electronics, antenna and filter systems) for low cost mm-wave and THz- applications
 - Use of new manufacturing methods
 - Integration of beam steering mm-wave TRX frontends
 - Integration with fiber infrastructure
 - Light -> THz conversion
 - MMIMO approaches
- Realize highly flexible and self-adapting Gbps indoor network nodes for mm-wave access and backhaul solutions

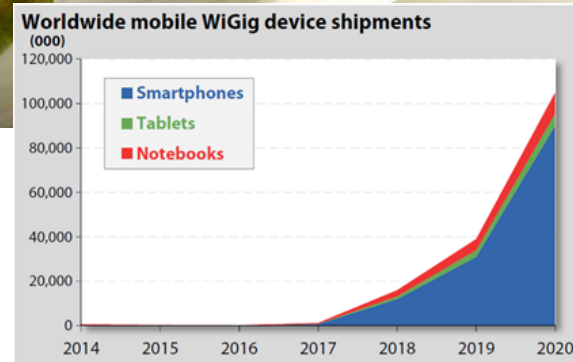

NOKIA